

www.tsms.kr

REFLOW

TSM *ECONOMY*

Ultra low power consumption efficiently to cope with CO₂ environmental regulations, realizing the lowest N₂ consumption, stable high purity and supplying nitrogen gas with low dew point. Experience outstanding next generation Reflow with a full line-up.



TSM Co., Ltd.



Please scan the QR code using a smart phone.

Reflow

Full Line-up

System



➤ TRN III a series N₂ Reflow

- Semiconductor Flip chip / Wafer / Solder-ball / Stack / MLCC / Module
- Electronic Device Mobile phone, Mini LED TV, Micro LED TV, IT
- Defense, medical, aviation



➤ TRN III Twin Reflow

- Independent 2 Reflow, Mass production, mixed flow fan production

Application



➤ **TRV Vacuum N₂ Reflow**

- Automotive, LED main light source, ADAS, MCU, ECU, BMS



➤ **TRV Vacuum Twin N₂ Reflow**

- Automotive, Electronics, etc.

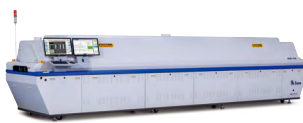

➤ **TRN III h High temperature Reflow**

- Automotive, Electronics, etc.



➤ **N₂ Generator**

- Stably supply highly purified nitrogen gas to N₂ Reflow



➤ **TRA Air Reflow**

- Home appliance, small home appliances, laundry, refrigerator, A/C, cleaner



➤ **TRN III Dual Conveyor**

- 2 Conveyor, mass production



➤ **Detachable Reflow**

- Best for limited space for equipment installation
- realize equivalent performance after combination



➤ **Compact / Slim Reflow**

- Flip Chip / BGA / Pre-Flux, etc.



➤ **Single-sided Reflow**

- Alternative Solution for Wave Solder

Customized

Features of Reflow



Convenient Monitor Configuration

MM ↔ RTPM ↔ Rppm program with tripartition of Wide Monitor for user interface enables users for easy access and convenient reading

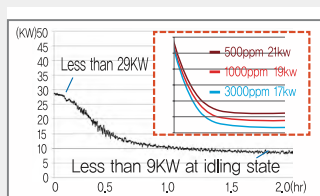

Energy Saving System

Up graded even ppm control technology for all Zone realizes significant reduction of power use compared to a previous model. Also, it ables to control quantity of its flow up on ppm setting

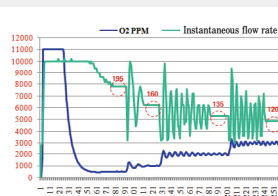

N₂ Flow Control System

Consume setting target of N₂ quantity required to maintain required ppm inside of Reflow oven in a way of N₂ quantity control (Previous models brings a result of energy loss due to a fixed consumption of N₂, not aligned with ppm set)

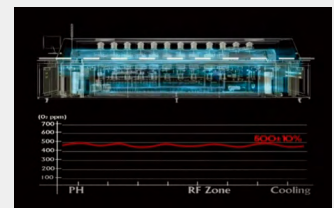

O₂ Control System

Realize concentration control of high purification by auto control of Oxygen concentration (even control system for all zone)

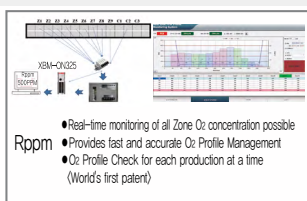

Rppm / Option

Real time Oxygen Concentration Profile System, Rppm provides ppm information for respective zone by measuring Oxygen concentration in real time inside of its oven and maintains consistency of Nitrogen inside of oven according to repetitive measurements,



RTPM / Option

One step forward developed Real Time Temperature Profile System, RTPM provides abundant information, compatibility, process index for analyzing process capacity and chart data.

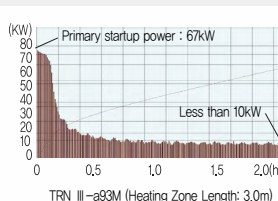

Power Consumption when stable

TRN III-a93M, in-house developed product enables power consumption significantly compared to previous models.

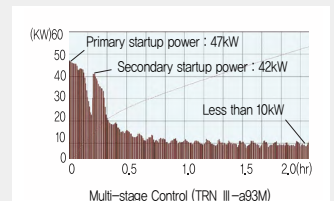

Partial Start Up Mode

Minimize Peak of power consumption by controlling two stages on heater temperature. Able to reduce basic power consumption and capacity of contract power.

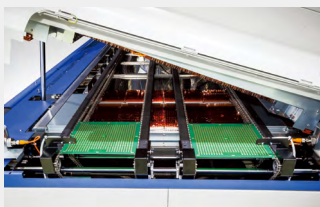

Dual Conveyor / Option

Dual Lane (Option)
- Increase Productivity (compare to previous Single Lane)
- Extendability and maximizing convenience → Dual Lane Corresponding 400mm in max. width.
- Fixed anchorage installation according to customer's need → RMMF/ RMM (F: Fixed, M: Movable)

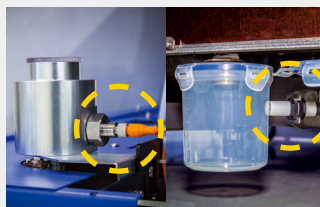

Oil level sensing for C/V chain

Alarming function when oil drops under target gage of oil for C/V chain.

Sensing the level of Flux capacity of FMS Function

A function that notifies the Flux PM cycle with an alarm after detecting the Flux level in the FMS's Drain Bottle.



Embedded PSA / Option

All-in-one embedded PSA interfaced with equipment provides innovative space use and stable operation environment to users through sophisticate PC control to large capacity and high purification.

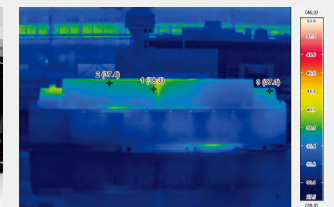

Surface temperature

Result of low power consumption and surface temperature insulated to the temperature, no harm to user and ventilation system

We dreamed of futuristic Reflow

Enjoy experiencing innovative functions with its evolution.

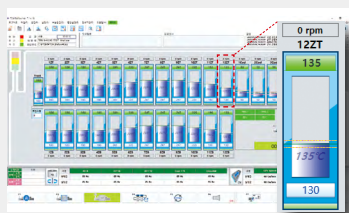

➤ Number of Spinning Blow Motor & Real Time Monitoring System of Heater Quantity Output

- Real time monitoring spinning numbers of Blow Motor: checking normal operation status of motor spinning in each zone and alarm function applied.
- Heat Output in real time monitoring: apply alarm if abnormal temperature increase of heater output in each zone.

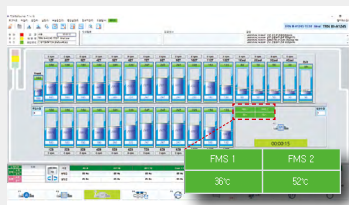

➤ FMS real time monitoring system of circulation temperature

- Checking operation condition of FMS in real time; if abnormal, alarm functions.



➤ FMS(Flux Management System)

- Highly efficient Flux collection capacity thanks to applying New Flux dust collection device and improvement of contaminated materials
- Improve period of PM and maintenance
- Support Quick replacement system of dust collection device (for Docking)

- Effective energy saving through cutting power loss and minimizing temperature changes indoors by optimized insulation of thermal efficiency.
- Wide monitor with three split screens allows multi tasks, easy accessible screen configuration and an operation system as well as its identification.
- MMI screen composed of user friendly configuration provides temperature monitoring function, operation maintenance alarm, calibration between temperature and oxygen and even supporting manual with pop up helping desk window for program operation.
- RPPM (real time O₂ PPM profile monitoring), patented by TSM allows real time monitoring on conditions of Reflow's inner O₂ ppm without profile measuring devise and indication with graph on ppm for all zone.
- WL-RTRM (Real Time Temperature Profile Monitoring) of TSM is improved for failure of sensor on existing sensor method and issues caused by impurity and also enables real time temperature profile work aligned with T-Profilier, invented internally by TSM & decision making process of SPEC IN/OUT.
- TSM invented all programs (MMI, RTPM, RPPM), optimized for company's Reflow and provides consolidated governance thanks to provision of customer server through Single Interface on all associated information about Reflow.
- FMS, large capacity, tailored for characteristics of the equipment enables cleaning cycle by collecting Flux efficiently and also improve customer's productivity by reduction of PM, attributed to applying One touch docking method.
- Large capacity and embedded for Latest cutting edge ESP, supplying high purified Nitrogen enables work space for customer, stable operation thanks to micro control with PC on Reflow to ESP and economic benefits such as cost saving. Parts mounted in front of the equipment for efficient check up and maintenance.
- Partial Start-up to control heater with stages enables to low contract power by minimizing starting power and to reduce base power cost; improved work efficiency due to operation date and scheduled time reservation through weekly timer function.
- New design optimized for functionality of Reflow is considered to maximize outflow of Flux and provision of stable temperature supply in oven and to secure work space on in/out exit for its maintenance as well as applying outstanding painting and color, highly resistant against contamination and changing colors.

N₂ REFLOW

TRN III - a SERIES

2 FMS for Cooling zone and Pre-heating zone (Option)
Maximizing Flux collection by applying large capacity of FMS

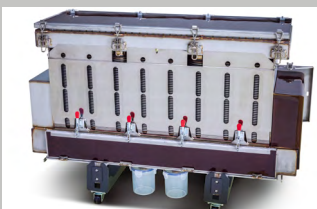

One touch removable type 2 Way Radiator

Realized improvement of product quality through reduction of Flux inside of oven and collection rate of Flux due to additional installation of highly performed FMS, optimized the equipment in PH. Reduce downtime by applying one touch sliding removable type and level sensor of FMS's Flux contain. This sensor alarms when fill it up.

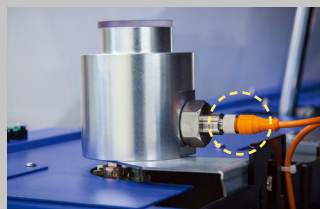

Oil level detection sensor for C/V chain

Sensing function of Conveyor Chain Oil Level alerts protection of C/V chain in case of shortage of oil with functions of alarm and message during operation.

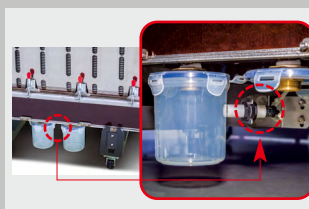

Flux level sensing Flux Drain Container

Detect precise cleaning time of Flux through alarming and message on level of Flux, collection container of Flux Management.



RTPM (Real Time Temperature Profile Monitoring System)

- Temperature Profile Memory Function per production and product type
- No need on Profile Check when changes of production model
- Real time saving of Reflow information (basic one minute in scale)
- Able to checking temperature condition of Reflow with real time graph
- Provide all information of Reflow through host computer communication
- Interface TSM Reflow MMI Program

Ceaseless innovative TRN series for the best Reflow offers the utmost customer satisfaction with the outstanding models, aiming Economy and Humanism, a core philosophy of TSM

NEW FMS, Heat Discharging System

Circulate the air in order to cluster Flux inside of oven and exchange the heat continuously
Heat discharging system newly mounted realizes cost saving of its ventilation during process by emitting the heat through the way of closed duct.

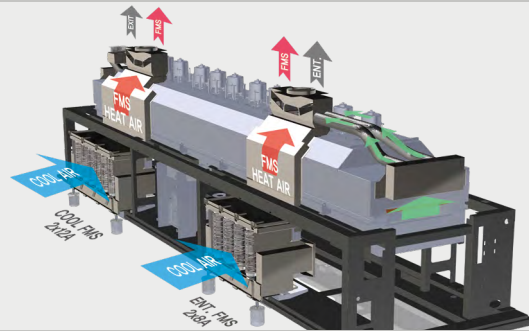

RPPM (option)

Monitoring conditions of O₂ ppm in all zone at all time, managing O₂ ppm Profile Graph Data according to types of production products with time slot and Spec and producing quality products while maintaining even O₂ ppm.

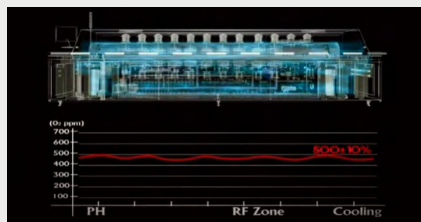

2 RADIATOR (option)

Achieved double performance of collecting flux by applying additional FMS in zone of Pre Heating on top of FMS in cooling zone and also able to extend a period of FMS's PM.

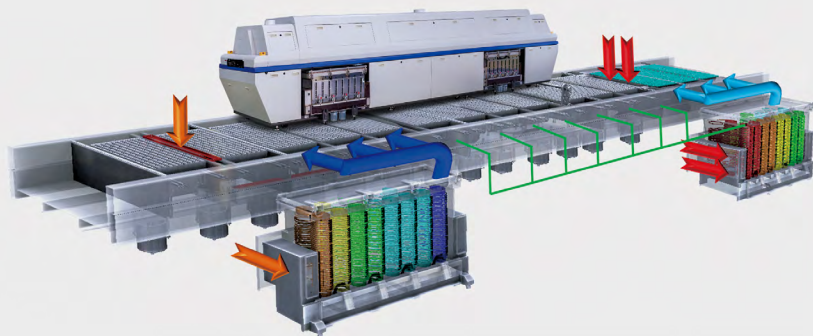

Flux Management System



Efficient collecting Flux and reduction of PM time

Model

Model	
N ₂ Type	For Semi conductors
TRN □ - a92 ^M	TRN □ - a52 ^M
- a93 ^M	- a82 ^S ^W
- a102 ^S	- a93 ^M
- a103 ^M	- a124 ^S

Model Numbering

TRN □ - a(h) 9 3 ^M ^S ^D ^W

D : Dual / () : Single
Heating Zone Size
Cooling Zone Count
Heating Zone Count
Model Series(h : For high temperature)

VACUUM REFLOW

TRV - SERIES

*World best productivity!! (Realized Lowest Tact Time)
Doubled Production Tact Time achievable with Twin vacuum system
(Min 30 sec → Min 15 sec)
Optimized TWIN VACUUM REFLOW for Mass production line!!!*



TRV - TWIN

TRV - SINGLE



(ETC Technical cooperation)

Overview

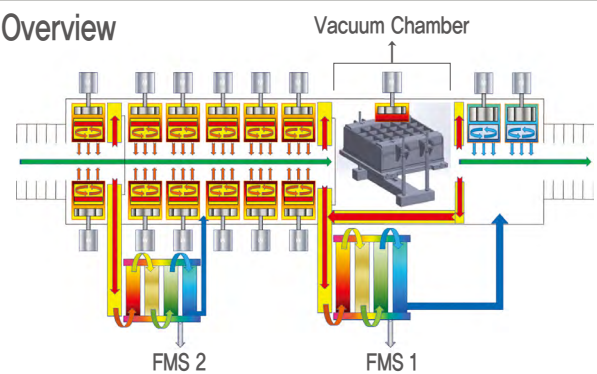

- ▶ Two Vacuum chamber + Two ovens, independent operation
- ▶ Reduction of production line space with compact design
- ▶ Independent system for each lane (temperature setting per lane, production available with one lane when one lane is PM)

01. Effect of vacuum function

Solder	Atmosphere	No atmosphere + vacuum	Void reduction
Company A SAC305			20.3%~3.2% 16.4%~2.43% 1/6 or less
			11.8%~1.9% 9.1%~0.4% 1/9 or less
Company B void countermeasure			8.8%~0.7% 3.5%~0.6% 1% or less

Combination of heating up heat wind circulation and vacuum reduces occurring Void despite of large space soldering.

02. Effect of reduction of Void

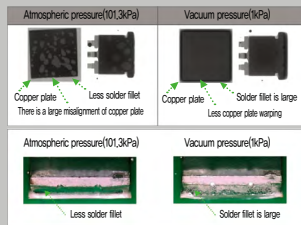

Secure forming fine fillet with thin and event solder thanks to reduction of Void and effect of self alignment from swelling and twisting.

03. PCB transferring system optimized for in-line production



04. Heating performance

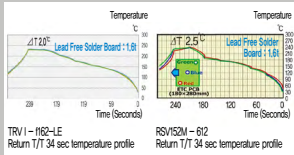

Secure high quality Soldering with even lower number of zone through combination of vacuum chamber and up / down heating circulation, improved for previous temperature profile condition.

05. Ultra low power consumption

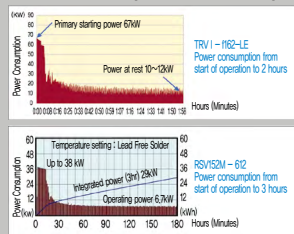

Realize ultra low power consumption through "RO" lightening main body and high insulation and saving of energy, CO₂ and electricity cost.

06. High insulation specification

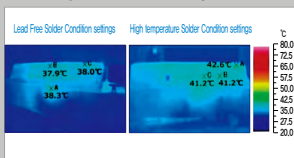

Combination of the low thermal conductivity, doubling insulation materials, resinification of insulation cover and ultra low power consumption of electricity enables dramatic reduction of energy and CO₂.

07. Collecting System of Flux (TSM)



TSM : Single Assy structure combined for each UNIT enables one touch separation, exchange and re operation; able to extend Flux PM period by applying 2FMS on recent equipment.

ETC : Highly perform on collecting Flux thanks to deploying dust collection UNIT, respectively per preheating, heating and cooling process and easy access on cleaning with cleaning liquid due to separating filter each box.

08. Vacuum Chamber

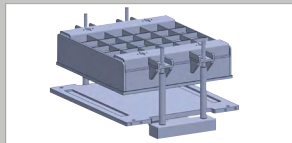

Effective degree of vacuum with complete close vacuum chamber enables to control and reduce Void effectively.

09. Filter Unit



Protect Flux contamination of Vacuum Pump through multi-staged filters and realize simple cleanin.

10. Controlling degree of a vacuum with three stage

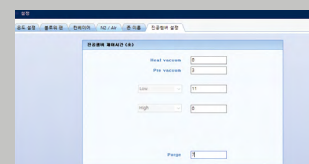

Flexibly handling control of degree of a vacuum with multi stage control according to characteristics of product.

11. MMI realization function of degree of a vacuum graph (Option)

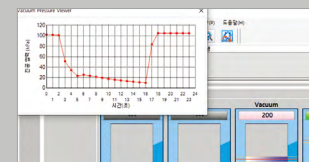

Able to monitor degree of a vacuum with its graph on MMI monitor.

12. RPMS: indicating a number of spinning MMI function for all zone B/M rpm (Option)



Visualize a number of spinning blower motor fans in real time. Alert with alarm if out of setting order caused by an error of its motor.

Specifications

Name of Models	TRV I - f612-WD	TRV I - f612-LE	TRV III - a612WT	TRV III - a612LT
Heating (zone)		6		
Vacuum (zone)		1		
Cooling (zone)		2		
Voltage		3Ø 380V		
Heating temperature		Max 350 °C		
Degree of vacuum		1~10 kPa		
Consumption capacity of nitrogen		300~400 l / min		
Outer length	5,406mm	6,286mm	5,406mm	6,286mm

※ Product specification indicated on this page may changeable without notice in advance for product improvement or company's internal situation.

Name of Models	TRV I - f612-WD	TRV I - f612-LE	TRV III - a612WT	TRV III - a612LT
Outer width		1,510mm	2,525mm	2,365mm
Outer height			1,550mm	
Height of passing parts			Upper 30mm / Lower 30mm	
Width of control panel	100~330mm	100~250mm	100~330mm	100~250mm
Length of control panel	100~250mm	100~330mm	100~250mm	100~330mm
Height of remand			900~920mm (STD 900mm)	
Collection of Flux			Standard mounting (2 FMS)	
Option			Roller mounted rail / large size chamber / 3Ø 380V other voltage	

N₂ REFLOW TRN SERIES

Built-in PSA REFLOW *(Built-in System)*

*Minimizing N₂ loss and power consumption,
Embedded System, realizing Eco friendly and
Ultra Power Saving*



Design your space with nitrogen generator (PSA) embedded inside of Reflow!

*N₂ generator with compact design, considering work environment,
embedded inside of Reflow does not require additional space and saves energy up to
20~30% of its energy by interfacing energy saving nitrogen generator (ESP serieses)
and Reflow MMI.*

*Superior outstanding Upgraded Reflow in the world,
TRN II-PSA, overcomes the limitation and satisfy with Functionality,
Economic Feasibility and Practicality*

- The most advanced Reflow “TRN II- PSA series”, controlling flow control and purification of N₂ implemented PSA (embedded) as a premier in the industry.
- Realize energy saving through auto control of N₂ interfaced with Reflow.

*Boasting outstanding special design of its equipment during the
downtime as well as full satisfaction with Functionality,
Economy and Practicality*

- The most advanced N₂ generator (TRN II-PSA series) with nitrogen purification of a N₂ generator and flow control introduced embedded type in the industry’s first, consequently improved for work space; easy access and stable operation through precise control of Reflow MMI.

Innovative “TRN II-PSA series” with an optimized N₂ generator and interfaced Reflow MMI allow auto control of nitrogen output in the industry’s first, consequently it contributes energy saving as well as minimizing nitrogen consumption and keeping stable ppm with stable quantity of minimum N₂. As a result, it solves issues of both Reflow oven and operation of a N₂ generator.

- For easy maintenance, the core parts are mounted in front of an embedded nitrogen generator. User can easily access system operation through planned operation maintenance schedule with setting time and alarm on New MMI, specialized for a N₂ generator, considering utmost user convenience and superior design.

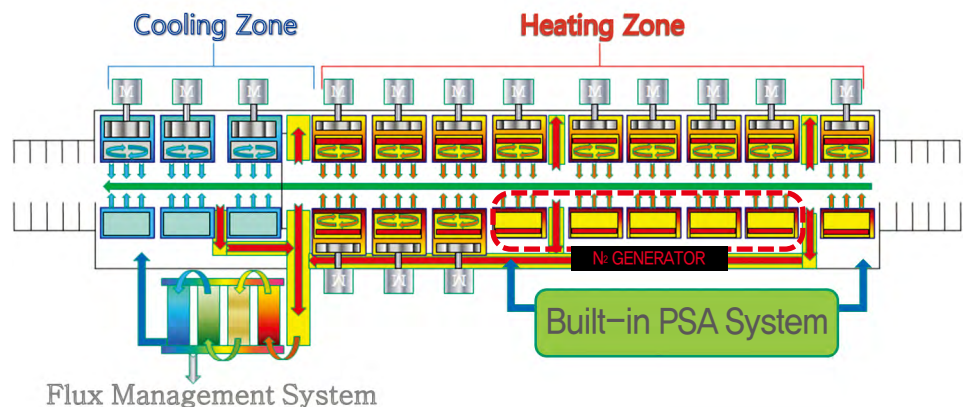

Smart Energy saving Air convection Reflow oven

- Leading industry standard of consumption power with strong customer support.

TRA series, the most output to realize superior performance and Economy

- Realize ultra low consumption power in order to reduce CO₂, eventually Economy, key words of TRA series under ceaseless technical development, Partial start-up mode heats up the reflow system in 2 steps to minimize the peak electricity, which greatly saves the operational cost for the factory with lower contracted power.

It reduces basic electricity cost and improve efficiency of productivity with weekly timer function, setting equipment operation date and time of its reservation.

Also, heating zone is diversified in order to cope with characteristics of production shape of various boards and maximized heating efficiency with newly designed nozzle structure, improved for air flow resistance.

The best product is realized thanks to contribution of the lowest temperature deviation, applied for an advanced ultra uniform temperature control system.

TRA series offers an efficient production method with up and down heating and also can switch heating method beside of a way of up and down. User friendly configured

MMI screen shows a various functions such as temperature monitoring, period of operation maintenance alarm, calibration of temperature and help pop up window for program running while considered user's easy access and its convenience in maximum.

RTPM (op), a Real Time Temperature Profile Monitoring System offers abundant information, compatibility and the process index & data chart for analyzing process.



Why should you use TSM' s reflow?

- ✓ *System configuration with outstanding durability*
- ✓ *Reliable quality*
- ✓ *Energy saving insulation structure*
- ✓ *Blower motor with triple sealing*
- ✓ *Reliable follow-up management*

AIR REFLOW

TRA-f SERIES

Innovative TRA-Series for discharging Flux efficiently and thermal management of high efficiency

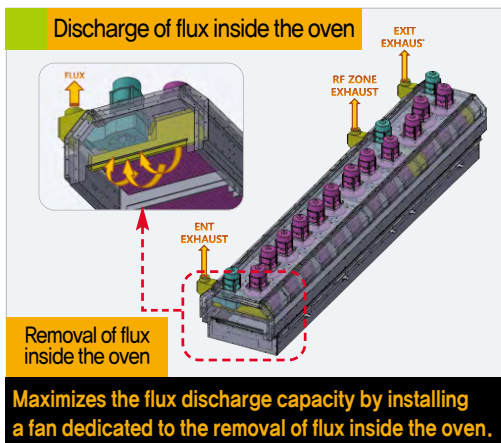

Model

Air Type	
SDW	MDW
TRA □ -f82S	TRA □ -f71M
-f102S	-f82M
	-f92(3)M
	-f123M
	-f132M

Model Numbering

TRA □ - f 10 2 ^MSDWH

Model Series | Heating Zone Size | Cooling Zone Count | Heating Zone Count

D : Dual / () : Single

(Items not indicated correspond to ^M)

PSA N₂ Generator

ESP - SERIES

Flexible set up the purity and quantity of consumption of O₂ through GUI (Graphic User Interface)



Features

- Allow interfaced operation with MMI of Reflow and excellent energy saving with ppm control
- Flexible setting function of N₂ purity and consumption quantity through Computer GUI (Graphic User Interface)
- Innovative operation program applied for checking diverse information of DATA with Graphic Chart
- Touch Panel applied for improvement of maneuverability and user's convenience
- Minimize changes of flow up on input data with electronic valve

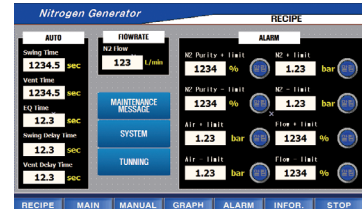

Interfaced Operation with Reflow (TSM)

Reflow offers control operation, interfaced between Reflow operation program (MMI) and ESP. N₂ generator is flexibly maneuverable according to operation conditions and production models (ppm). Consequently achievable for energy saving.

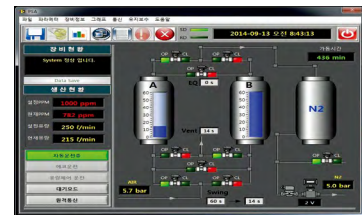

Easy Touch Panel

More improved for user convenience by selecting Touch Panel.

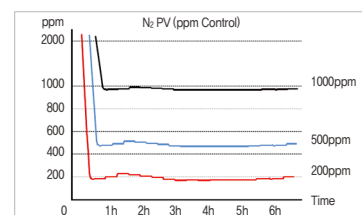

Control of N₂ Purity

Able to set up N₂ purity, generated in the unit of ppm and selectively controllable for SwingTime.



PSA interfaced control with Reflow

Able to control respective ppm through interfaced control between Reflow and PSA and excellent for energy saving.

N₂ Generator, Eco friendly and low power consumption corresponding effectively for customers' demand

N₂ GENERATOR

➤ *Easy transferability with compact size and low noise for convenient control.*

Compact Size

Maximize utilization of space with compact design.

Flexible installation and transfer

Flexible transfer and install with mounting standard Cluster for all models.

Low noise

Easy control indoors thanks to low operation noise

Simple maneuverability

Displaying operational control and its condition on Display Panel as well as O₂ purity with simple maneuverability.

➤ *N₂ Generator, consistently and stably supplying nitrogen gas of high purity to N₂ Reflow M/C!*

Easy Maintenance

Easy maintenance by applying reliable outstanding solenoid valve.

Simple

Supplying nitrogen gas of high purity with power-on

Supplying N₂ Gas of high purity and low dew point stably

▷ ESP-Type Moving PSA

Model	Capacity Nm ³ /Hr (99.99%)	Discharge Pressure (Mpa)	Weight (kg)	Dimension L x W x H(mm)
ESP-N6RT-99	6	0.5	400	1,270 x 420 x 1,215
ESP-N10RT-99	10		710	1,560 x 520 x 1,260
ESP-N12RT-99	12		730	1,560 x 520 x 1,260
ESP-N15RT-99	15		810	1,560 x 520 x 1,360
ESP-N18RT-99	18		880	1,560 x 520 x 1,460
ESP-N20RT-99	20		960	1,560 x 520 x 1,610
ESP-N25RT-99	25		1,160	1,860 x 620 x 1,550
ESP-N30RT-99	30		1,360	2,010 x 670 x 1,550



ESP-Series

▷ TPC-Type PSA

Model	Capacity Nm ³ /Hr (99.99%)	Discharge Pressure (Mpa)	Air Compressor (kw)	Weight (kg)	Dimension L x W x H(mm)
TPC-N40R-99	40	0.5	30	1,900	1,450 x 950 x 2,300
TPC-N50R-99	50		2,400	1,500 x 1,100 x 2,400	
TPC-N60R-99	60		37	2,700	1,650 x 1,100 x 2,600
TPC-N80R-99	80		55	3,200	1,800 x 1,200 x 2,800



TPC-Type

* N₂ Service Tank는 포함되지 않음

▷ TP-Type PSA

Model	Capacity Nm ³ /Hr (99.99%)	Discharge Pressure (Mpa)	Air Compressor (kw)	Weight (kg)	Dimension L x W x H(mm)
TP-N40R-99	40	0.5	30	1,830	1,450 x 1,700 x 2,400
TP-N50R-99	50		2,340	1,500 x 1,750 x 2,550	
TP-N60R-99	60		2,610	1,750 x 1,900 x 2,600	
TP-N80R-99	80		55	3,100	1,870 x 2,100 x 2,750
TP-N100R-99	100		75	3,200	1,850 x 1,800 x 3,000
TP-N120R-99	120		90	3,400	1,950 x 1,800 x 3,200



TP-Type

N₂ GENERATOR

➤ Example of installation in a line

〈 N₂ Generator(TPM-Type) + N₂ Reflow Flow Diagram 〉

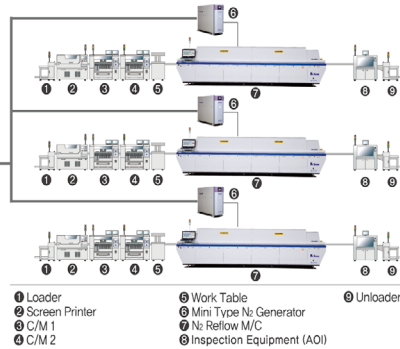
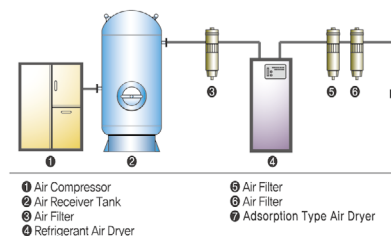

〈 N₂ Generator(TP-Type) + N₂ Reflow Flow Diagram 〉

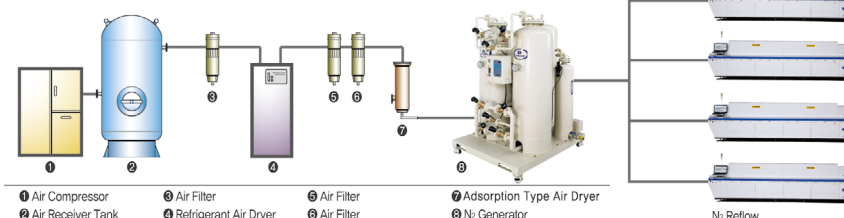

➤ Test Room

(Inspection and Certifying Test)



EQUIPMENT

Division	Item	TRN III	TRA-
Mechanism	Basic Sheath Heater	●	●
	Triple Sealed Blower Motor	●	●
	Detachable FMS	●	-
Operation	C/V Chain + Center Support	●	●
	Special Attachment Chain	●	●
	C/V Width Semi Auto	●	●
	Torque Limit (Overload Prevention)	●	●
Convenient Function	RTPM	▲	▲
	Oil Level and Sensing for C/V Chains	▲	▲
	Flux Recovery Level Detection in FMS	▲	-
	2 FMS (2 Radiator)	▲	-
	Blower Motor Separate Type	▲	▲
	PSA Built in Type	▲	-
	C/V Chain + Mesh	▲	▲
	C/V Chain + Two Center Support	▲	▲
	Mesh Belt Only Type	▲	▲
	Low Vibration Mesh Belt	▲	▲
	C/V Width Full Auto	▲	▲
	Dual Type (Simultaneous F/R Control)	▲	▲
	Dual Type (Independent F/R Control)	▲	▲
	N ₂ Quick Charger	▲	-
	Cooling Zone Heater	▲	▲
	Integrated Power Meter	▲	▲
	N ₂ Accumulated Flow Meter	▲	-
	B/M Fail Detection Sensor	▲	▲
	RPPM	▲	-
	Bar Code Function	▲	▲
SMEMA	▲	▲	
CE	▲	▲	
Others	SECS/GEM	▲	▲
	Dual Monitor	▲	▲
	T-Profilier	▲	▲

● : Standard ▲ : Option - : Not Applicable



Factory in Sihwa MTV Complex

Contact for Business Services and Purchasing



TSM Co., Ltd.

57, MTV 26-ro 20beon-gil,
Siheung-si, Gyeonggi-do,
15118 Rep. of KOREA
TEL : +82-31-499-4895
FAX : +82-31-499-4895
E-mail : sales@tsms.kr
http://www.tsms.kr

